

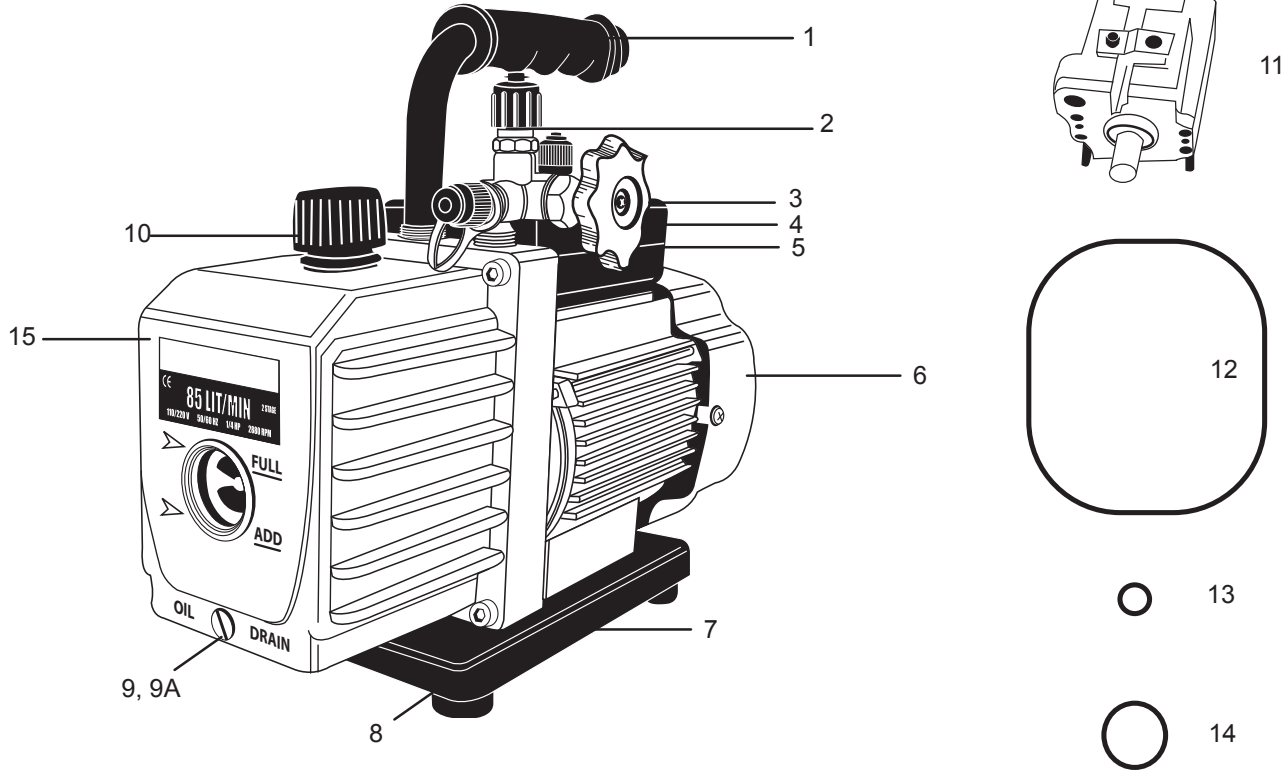

Mastercool[®] Inc.
"World Class Quality"

**3 CFM TWO STAGE
 VACUUM PUMP**

**REPAIRABLE PARTS BREAKDOWN
 (90063-2V)**



REF. #	DESCRIPTION	PART #
1.	HANDLE	90066-H
2.	T-FITTING	90056-18-R
3.	110V POWER CORD 220V POWER CORD	6535-110 6535-220
4.	ON/OFF SWITCH	98300-006-66
5.	ELECTRICAL BOX	90063-2V-EB
6.	FAN COVER	90063-FC
7.	BASE PLATE WITH SCREWS	90066-2V-BP
8.	RUBBER FEET	90066-2V-15
9.	OIL DRAIN PLUG WITH O-RINGS	90066-2V-28
9A.	OIL DRAIN PLUG	90052-29
10.	EXHAUST FITTING	90066-10
11.	CARTRIDGE	90063-2V-03
12.	PUMP COVER O-RING	90063-2V-13
13.	CARTRIDGE O-RING	90063-2V-22
14.	CARTRIDGE O-RING	90063-2V-24
15.	PUMP COVER	90063-2V-12